

vtech®

User's Manual

# KidiPet Friends



© 2014 VTech  
Printed in China  
91-002907-005 UK

**VTech understands that a child's needs and abilities change as they grow and with that in mind we develop our toys to teach and entertain at just the right level...**

## **vtech** Baby

**Toys that will stimulate their interest in different textures, sounds and colours**

### **I am...**

...responding to colours, sounds and textures

...understanding cause and effect

...learning to touch, reach, grasp, sit-up, crawl and toddle

Birth-36 months



## **Pre-School**

**Interactive toys to develop their imagination and encourage language development**

### **I want...**

...to get ready for school by starting to learn the alphabet and counting

...my learning to be as fun, easy and exciting as can be

...to show my creativity with drawing and music so my whole brain develops

3-6 years



## **Electronic Learning Computers**

**Cool, aspirational and inspiring computers for curriculum related learning**

### **I need...**

...challenging activities that can keep pace with my growing mind

...intelligent technology that adapts to my level of learning

...National Curriculum based content to support what I'm learning at school

4-10 years



To learn more about this and other VTech® products, visit [www.vtechuk.com](http://www.vtechuk.com)

# INTRODUCTION

**KidiPet® Friends** pony is a cute, smart virtual pet that features a touch screen to feed, play and teach tricks to your new friend! Connect to other kidipet friends units to add friends. Send them gifts, fun emotions and enter a friendly balloon race! Take good care of your pet to reach higher levels of game play and receive rewards!

## INCLUDED IN THIS PACKAGE

- **KidiPet® Friends** Main Unit
- Desktop Stand
- Strap
- User Manual





**WARNING:** All packing materials such as tape, plastic sheets, packaging locks and tags are not part of this toy, and should be discarded for your child's safety.

**NOTE:** Please keep user's manual as it contains important information.

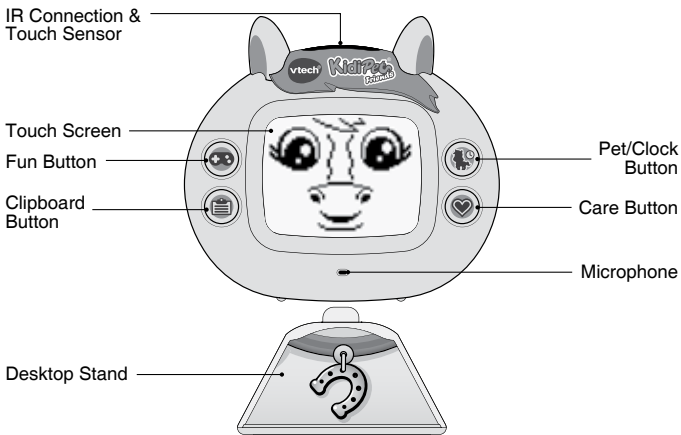
## FEATURES

### Product Layout and Buttons



	<b>Pet/Clock Button</b> Press this button to toggle between <b>PET</b> mode and <b>CLOCK</b> mode.
	<b>Care Button</b> Press this button to show the <b>CARE</b> Menu.
	<b>Fun &amp; Outings Button</b> Press this button to show the <b>FUN &amp; OUTING</b> Menu.
	<b>Clipboard Button</b> Press this button to show the <b>CLIPBOARD</b> Menu.

<b>LCD Touch Screen</b>	Tap on the screen to make your selection, you can also interact with the <b>KidiPet® Friends</b> with Gesture Commands.
<b>IR Sensor</b>	Used for connecting two <b>KidiPet® Friends</b> . (IR connection is for <b>KidiPet® Friends</b> only. Older versions of KidiPets and other devices are not compatible.) Recommended IR range between 0 cm – 30 cm.
<b>Special Pat Sensor</b>	<b>KidiPet® Friends</b> love to be pat on the head. Move your hand across the sensor to pat them on the head when they are in desktop mode.

**Note:** For best performance, keep the unit away from direct sunlight and avoid covering the top of the unit.

## GETTING STARTED

### Battery Installation

**KidiPet® Friends** uses 2 AAA size batteries.

- Make sure the unit is OFF or in clock mode.
- Locate the battery cover at the back of the unit. Turn the lock clockwise for a quarter turn with a flat head screwdriver (not included).
- Remove the battery cover and install 2 AAA size batteries as illustrated. (The use of new, alkaline batteries is recommended for maximum performance)

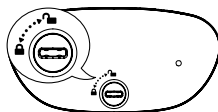
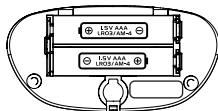

- Close the battery cover and turn the lock anti-clockwise for a quarter turn.

## Battery Notice

- Use new alkaline batteries for maximum performance.
- Use only batteries of the same or equivalent type as recommended.
- Do not mix different types of batteries: alkaline, standard (carbon-zinc) or rechargeable (Ni-Cd, Ni-MH), or new and used batteries.
- Do not use damaged batteries.
- Insert batteries with the correct polarity.
- Do not short-circuit the battery terminals.
- Remove exhausted batteries from the toy.
- Remove batteries during long periods of non-use.
- Do not dispose of batteries in fire.
- Do not charge non-rechargeable batteries.
- Remove rechargeable batteries from the toy before charging (if removable).
- Rechargeable batteries are only to be charged under adult supervision.

## Disposal of batteries and product



The crossed-out wheellie bin symbols on products and batteries, or on their respective packaging, indicates they must not be disposed of in domestic waste as they contain substances that can be damaging to the environment and human health.



The chemical symbols Hg, Cd or Pb, where marked, indicate that the battery contains more than the specified value of mercury (Hg), cadmium (Cd) or lead (Pb) set out in Battery Directive (2006/66/EC).

The solid bar indicates that the product was placed on the market after 13th August, 2005.

Help protect the environment by disposing of your product or batteries responsibly.

For more information, please visit:

[www.recycle-more.co.uk](http://www.recycle-more.co.uk)

[www.recyclenow.com](http://www.recyclenow.com)

## Low Battery

When the battery power is low, the main unit will turn OFF automatically. If you see the Low Battery icon appear on screen please replace the batteries.



## Basic Touch Screen Operation

Tap or swipe the screen to operate your KidiPet.

In all menus, tap the icon on screen to enter or make the selection.





If the menu has more than 1 page, you can tap on the arrow, or use a gesture command to change the page. Slide from right to left to change to the next page and slide left to right to change to the previous page.



## Initial Setup

If you've just taken the **KidiPet® Friends** out of the packaging for the first time, you need to disable the Try Me Mode before playing.

To disable the Try Me Mode, press the **PET / CLOCK** button  to wake up the pet and then press the **CLIPBOARD** button  to exit the Try Me Mode.

You have to set your own language, the date and the time before starting. Tap the desired language icon and then tap the ✓ icon to confirm your selection.



Next, set the date and time. Tap on the Day / Month / Year to highlight the field, tap the arrows to adjust the value. Tap on the DD/MM/YY to change the date format to MM/DD/YY. Tap the ✓ icon to continue to set the time.

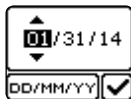

Tap on the hour/minute value to highlight the field, tap the arrow to adjust the value. You can select 12h or 24h system display on the screen. Tap the ✓ icon when finished.





**NOTE:** When you have replaced the batteries, you will need to verify the date & time again.

## TO BEGIN USING YOUR KIDIPET® FRIEND

### Getting your First KidiPet® Friend

After you have finished the Initial Setup, you will see a stork bringing your KidiPet! Remember to give your pet a name. Tap on the characters to enter a name, tap the arrow to see more characters in the list.



To delete a character, tap the space icon  in the character list. When you have finished, tap the  icon.

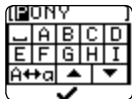

### Standby Mode

When the KidiPet is left without input, it will go to STANDBY Mode which will show the time and date. An alarm icon  will be shown if the Alarm Clock is set to ON.



## START PLAYING

Once the KidiPet is delivered, you have to take good care of it using the different buttons.

 **Pet mode / Clock:** Press this button to interact with your pet or switch to Clock mode.



 **Care Menu:** Feed, clean and take your pet to the clinic.

Feed (Kitchen)



Washing (Bathroom)

Toilet

Clinic



**Fun and Outings:** You can take your pet to different locations for different activities.

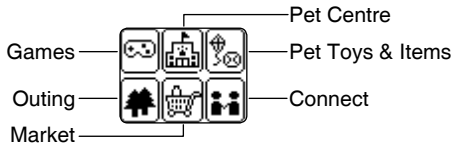



**Clipboard:** You can check the status, tasks and missions and edit your pet information here.



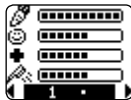

## The Behaviour of the Pet

There are 4 living indices affecting the pet behaviour: Food Index, Mood Index, Hygiene Index and Health Index.



Index & Indication	Affect	Solution
Low in Food index 	When this index is low, the pet is hungry and may refuse to do most of the activities and will not respond to any commands in PET mode.	Feed it as soon as possible.
Low in Mood index 	When this index is low, the pet is unhappy and may refuse to go to the Fitness Centre and will not respond to any commands in PET mode.	Play GAMES with it or take it on an OUTING to make it happy.



<p>Low in Hygiene Index</p> 	<p>When this index is low, the pet needs a wash and may refuse to do most of the activities and will not respond to any commands in PET mode.</p>	<p>Take it for a shower or a bath as soon as possible. Take it to the TOILET regularly to keep it clean.</p>
<p>Low in Health Index</p> 	<p>When this index is low, the pet is sick and may refuse to do many of the activities and not respond to any commands in PET mode.</p>	<p>Take it to the CLINIC as soon as possible.</p>
	<p>When it shows a sad face, check the status from the clipboard icon.</p>	<p>Take action if any index is too low.</p>

## Everyday Tasks

If you keep your pet in good condition, your pet will move onto a new level of game play. More items or tricks can be unlocked as your pet condition improves. To keep your pet in the best condition you will need to do the following:





1. Keep its 4 living indices Mood, Health, Food, Hygiene good. They need to have reached the maximum at least once a day.
2. Take your pet for a shower, brush its teeth and hair.
3. Interact with your pet in PET Mode at least 2 different times a day.
4. Take it out on an OUTING at least once a day.

## Finish the Mission to Level Up

When your pet is in good condition it will level up after a few days. Before leveling up the pet will be asked to complete a mission.

There are 7 types of missions:

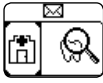
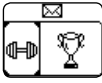

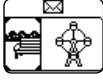
1		Go to the MARKET to buy a musical instrument.	2		Go to the CLINIC to take a vaccine.
3		Go to the CLINIC for a dental check.	4		Go to the FITNESS CENTRE to attend a fitness contest.
5		Go to the FOREST for a special trip to outer space.	6		Go to the BEACH for a special underwater trip.
7		Go to the PARK for a carnival trip.			

Go to the correct location and icon as the mission says and finish the mission as soon as you can, then your pet will go up a level. Afterwards, your pet may receive a reward which could be one of the followings:

1. New home made food. You can see the new food in CARE > FEED (KITCHEN) > Home made food.
2. A new secret item. You can see the new item in FUN & OUTINGS> PET TOYS & ITEMS.
3. A special trick. You can see the new trick in FUN & OUTINGS> PET CENTRE > PONY TRICK TRAINING.
4. A new secret card, emotional icon or gift item. You can see the new gift item in FUN & OUTINGS>CONNECT > SEND.
5. Play the bonus Coins Catching game.

If you cannot complete the mission, a new mission will be generated randomly.

## CLIPBOARD

Press the CLIPBOARD button  to enter the CLIPBOARD menu. Here you can find: Pet Status, Tips & Mission, Pet Information, Stamp Collection Box, Customise Pet Response and Settings.



## 1. Pet Status

You can monitor your pets status here.

: Food indices of your pet

: Mood indices of your pet

: Health indices of your pet

: Hygiene indices of your pet

: Friend index of your pet

: Intelligence index of your pet

: Pet's piggy bank, it shows the amount of coins collected by your pet. (Coins can be earned during game play.)

: Level status of your pet

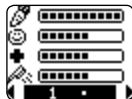

## 2. Tips & Mission

You can see some tips here. If there is a mission, you can see the mission details here.

Tap the first screen of tip or mission to get detailed information about it.



## 3. Pet Information

You can see the Pet's name, gender, birthday and all received messages from other **KidiPet® Friends**.

Tap on the the Pet Name to edit its name.

Tab on Postbox icon to view all received messages.

It will show the profile of sender or this symbol . Only the last 10 messages will be shown.



## 4. Stamp Collection Box

If your KidiPet has been well looked after, you will be rewarded with a stamp. You will find all the stamps in the stamp collection box.

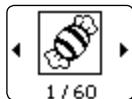

## 5. Customise Pet Response

Record funny responses for your pet to say!

Tap on the Record icon  to record. Start recording after the countdown.

Tap on the Play icon  to listen to your recording.

Tap on the Delete icon  to delete your recording.

If there is no recorded voice, it will use the system default response which cannot be deleted.

Pet Response 1 – for your pet to say when it is happy

Pet Response 2 – for your pet to say when it feels loved

Pet Response 3 – for your pet to say after eating

Pet Response 4 – for your pet to say after washing

Pet Response 5 – for your pet to say after seeing the doctor

Pet Response 6 – for your pet to say after an outing





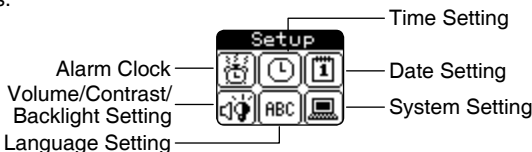

## 6. Settings

You can change the date, time, volume, backlight and languages in settings.





### a) Alarm Clock

To set the Alarm Clock, tap on the Alarm Clock icon  to go to the alarm time setup screen.

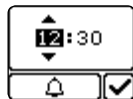
Tap on the hour or minute value to highlight the field and tap the arrow to change the time, tap the alarm icon to toggle alarm on  or off . Tap the  icon when finished.



When it reaches the alarm time, you will hear a sound. There will be an option of turning the alarm off or you can hit the snooze button. To stop the alarm, click the alarm off icon . If you have selected snooze the alarm will sound again after 5 minutes. To stop the alarm, click the alarm off icon .

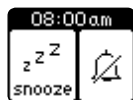

## b) Set the Time

To set the time, tap on the Time Setting icon .

Tap on the Day / Month / Year to highlight the field, tap the arrow to adjust the value. Tap on the DD/MM/YY to change the date format to MM/DD/YY. Tap the ✓ icon to continue to set the time.

## c) Date Setting

To set the date, tap on the Date Setting icon .

Tap on the Minute / Second value to highlight the field, tap the arrow to adjust the value. Tap on the 24 hour value to change to the 12 hour time display mode. Tap the ✓ icon when finished.

## d) Volume / Contrast / Backlight Setting

Tap on the Volume / Contrast / Backlight Setting icon

 to set these settings respectively.

To set the volume, tap on the desired sound volume level directly. Tap the ✓ icon when finished.

To set the contrast, tap on the desired contrast level directly. Tap the ✓ icon when finished.

To set up the screen backlight, tap on the icon to set to on or off. Tap the ✓ icon when finished.

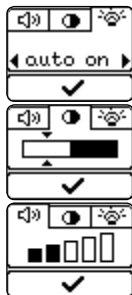

## e) Language Setting

Tap on the  icon to choose a language.

Tap the desired language icon and then tap the ✓ icon to confirm your selection.

## f) System Setting

Tap on the  to calibrate or reset the unit.

### • Calibration

If you find the touch screen is not very responsive, you can do a touch screen calibration, tap the ✓ icon to start the calibration. Touch all the + precisely on the touch screen to finish the calibration.

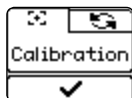

### • Reset

If you want to reset the unit and start again with a new pet, tap the ✓ icon to reset the unit.



**WARNING: This will erase all the pet data.**

# CARE



Press the CARE button  to enter the CARE menu.

Feed (Kitchen)



Washing  
(Bathroom)

Toilet

Clinic

## 1. Feed (Kitchen)



To feed your pet, you can choose Ready to Eat Food or Home Made Food.

### • Ready to Eat Food

This is an easy way to feed your pet. Choose food from the menu and feed your pet. The amount of food and water given to the pet by the system is unlimited. You can buy other food or drink from the Market. Food or drink bought from the Market can only be given once, if you want to feed your pet other food, you will need to visit the market again.



### • Home Made Food

You can cook food and then feed your pet. Follow the hints and complete the gesture commands on the touch screen to cook delicious food for your pet. Your pet will love it!





## 2. Washing / Bathroom



Here you can take your pet for shower and brush its hair and teeth.

 **Shower** – tap this icon to take your pet for a shower. Tap the touch screen to wash your pet with shower gel.

 **Hair Brush** – tap this icon to brush your pet's hair. Swipe the touch screen to brush your pet's hair.

 **Tooth Brush** – tap this icon to brush your pet's teeth. Swipe the touch screen to brush your pet's teeth.

 **Bath** – tap this icon to give your pet a bath. Swipe the touch screen to use the bath sponge to wash your pet.

**Note:** The Bathtub can be unlocked in later stages of the game.

### 3. Toilet

Touch the toilet icon to take your pet to the toilet.

### 4. Clinic

Take your pet to the clinic when it is sick. It costs 50 coins to take your pet to the clinic.

## FUN & OUTINGS

Press the Fun & Outings button  to enter Fun Mode.

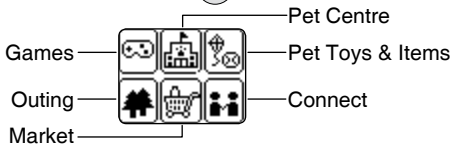

### 1. Games

You can play games with your pet to earn coins!

#### **Treasure Hunt**

Some objects such as a horseshoe will appear for a short while and then disappear from the screen. Tap the grid to bring your pet to find all the objects

#### **Finger Dance**

Tap on the arrows in the order they appear on the screen to see your pet dance.

#### **Pony Race**

Tap on the circles at the bottom of the screen alternatively to speed up your pony, let the pony rest for a while if it gets tired.

#### **Coins Catching (Bonus Game)**

This is a reward bonus game. It appears only when your pet reaches a new level. This bonus will be rewarded only by chance.

When the coins start falling, tap and hold on either the right or the left side of the screen to move the pet and collect the falling coins. It is a





bonus coin collection game! The coins fall quickly. Don't worry if you cannot collect them all, try your best to catch as many as possible. Good Luck and enjoy!

Once this bonus game is played, you will need to wait for a new level for another chance to play.

## 2. Pet Centre



 **Babble Talk** – tap this icon to talk to your pet using the microphone, it will try to repeat what you say.

 **Fitness Centre** – tap this icon for your pet to do some running, doing this will keep your pet in good shape! If your pet is in very good condition, it may even try some weightlifting exercise!

It costs 50 coins for every visit to the Fitness Centre.

 **Trick Training** – tap this icon to enter the trick training mode. Choose a trick for your pet to learn from the Trick Training menu. Follow the hint on the screen to show your pet how to perform the trick. Once the pet has learnt it, you can give them gesture instructions to complete the trick successfully.

There is a total of 12 Tricks in the Training Mode. Unlock them all to see how fun it is. When the pet reaches higher levels more tricks are unlocked. The Pet level can be viewed from the clipboard.

**Note:** Most tricks can only be performed once the unit is detached from the desktop stand mode.

## 3. Pet Toys & Items

Tap the item icon for your pet to view and to use its own items. Some items can only be used one time. If your pet wants to use the same item again they will have to unlock this item again.

## 4. Outings

Regularly going on outings will help keep your pet healthy and happy. There are 3 places to go.





Tap on the screen to see surprises when they are at the beach, in the park and the forest.

It costs 20 coins for every visit to these places.

## 5. Market

This is a place that you can buy or sell things. Swipe the screen to choose the Buy or the Sell menu, tap on the screen to make a selection.

-  **Buy** – Choose the object you want to buy then tap on the item to buy it.

If you've already owned the food or item, you will not be able to buy it again. It will show a Tick icon instead of the price.

If you don't have enough coins, play more GAMES to earn some more.

-  **Sell** – Tap this icon to see what you can sell. After you have sold the item, you will get back some coins. Not all of your items can be sold, but some special items are worth a lot of coins!

## 6. Connect

In the Connect mode, you can connect with another **KidiPet® Friends** main unit, where you can send messages, icons and pictures to one another!



Before connecting, make sure that only 2 units connect at a time. **KidiPet® Friends** cannot support more than 2 units connecting at the same time.

Make sure the units connecting are **KidiPet® Friends**, other units or other KidiPet versions will not get connected.



When they are ready, their screen will show the “Ready to be connected” animation.

For best results, wait for both units to show the same animation before connecting.

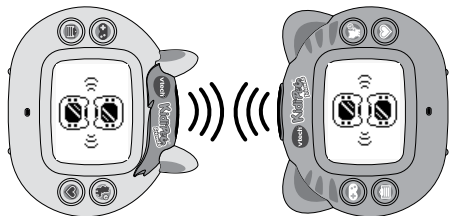
During connecting, both **Kidipet® Friends'** IR sensors have to be pointing to each other.



**Note:** The best IR connection range should be between 0cm – 30cm.

- **Hello Friend** – Tap the “Hello Friend” icon  on both units to add a **Kidipet® Friends**.
- **Balloon Race** – tap the “Balloon Race” icon  on both units to have a balloon race. Blow into the microphone to blow up the balloon then press the connect button and watch to see who goes further on their balloon!

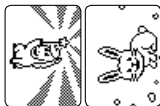

- **Send** – tap the send icon  and then select a card, emotional icon or gift to send to another **Kidipet® Friends** unit. Once confirmed, tap the screen and the other **Kidipet® Friends** unit needs to tap the Receive icon. When both units show the “Ready to be connected” screen at the same time, connect them with the IR sensors pointing to each other.

There are 10 cards, 10 emotional icons and 10 gifts that can be sent. When the pet reaches higher levels, more cards, emotional icons and gifts are unlocked for sending out.

- **Receive** – tap this icon  to start receiving a card, emotional icon or gift item from another **Kidipet® Friends** unit.
- **Friend List** – Tap this icon  to see the last 10 friends you have connected with.

**Note:** Both the **Kidipet® Friends** image or  picture show on the friend list is normal.

# PET/CLOCK



Press the **PET / CLOCK** button  to enter the PET Mode. If it is already in PET Mode, press this button again to switch to Clock Mode.

- **Attaching the main unit to the desktop stand**

Insert the kidipet unit on top of the stand. To ensure you have done this correctly you should see the animal collar at the front and it's tail at the back once the unit is in desktop mode.



If you insert the **KidiPet® Friends** main unit onto the desktop stand, you will see a close up image of your pet's face. Pat your pet's head by waving your hand over the sensor on the top of the unit (Special Touch sensor), and your pet will feel loved.

- **Kidipet® Friend Unit without the desktop stand**

If the unit is detached from the stand, it will automatically switch to show the whole image of the pet.



In the PET Mode, you can interact with the pet with the touch screen. Your pet already knows how to perform some tricks at the beginning. More special tricks will be unlocked once your pet reaches higher levels.

Please refer to the APPENDIX section, Table 2 of this manual for a full list of tricks.

- **Babble Talk**

You can teach your pet to speak in Babble Talk. In order to speak to your pet you need to make it come closer to the screen. To make the pet come closer to the screen swipe your finger from the bottom up to the top. When you have the pet in close up mode and you see the microphone icon speak into it and wait for your pet to repeat what you say. To make your pet move away from the screen swipe the screen from the top to the bottom. Speak into the microphone when there is a microphone icon showing on screen. The pet will try to listen and repeat what you say.



## • Listening Mode

When the pet's face is in close up mode you can talk to your pet and it will respond with its animal sound.



If your pet cannot hear you, you may need to move closer to the microphone. Try to speak slowly and clearly into the microphone. It will take a few moments for your pet to register what you have said.



# TROUBLESHOOTING

Check this section if you experience difficulty with operating **KidiPet® Friends**.

Problem	Solution
Your <b>KidiPet® Friends</b> has stopped working or the LCD does not display.	<ol style="list-style-type: none"><li>1. Ensure that the batteries installed correctly.</li><li>2. Replace with a new set of batteries.</li></ol>
The touch screen is not responsive or the response seems offset.	Try to do a touch screen calibration in <b>CLIPBOARD &gt; Settings</b> . When doing the calibration, use a fingertip to tap on the crosses on the screen as precisely as possible.
The volume decreases.	Replace with a new set of batteries.
The pet does not respond to your pat.	<ol style="list-style-type: none"><li>1. Ensure you pat the IR touch sensor at least 2 times continuously.</li><li>2. Ensure that the pet is not in listening mode.</li><li>3. Make sure nothing is blocking the IR sensor.</li><li>4. Make sure it is not too close to a wall.</li><li>5. Keep the unit out of direct sunlight and away from a bright source for better performance.</li></ol>

<p>The pet does not respond to what you say.</p>	<ol style="list-style-type: none"> <li>1. Ensure that the pet shows a close up image and shows the symbol  on screen.</li> <li>2. Try to speak clearly into the microphone. When the pet is responding to you, you cannot continue speaking until the pet has finished its response.</li> </ol>
<p>The pet does not repeat what you say in babble talk.</p>	<ol style="list-style-type: none"> <li>1. Ensure that the pet is in the babble mode with the microphone icon (  ) displayed at the corner of the screen. For details, please refer to the Babble Talk section.</li> <li>2. Try to speak closer and clearer into the microphone. When the pet has just repeated what you have said, give it a few seconds break before speaking again. Be patient, your pet needs some time to adjust to your voice.</li> </ol>
<p>The pet does not perform the trick according to my gesture commands and always shows question marks.</p>	<p>The pet will not be able to perform a trick if it is still locked. Take good care of your pet and when you get the chance to level up you can unlock these tricks. Please refer to APPENDIX Table 2 for details of locked tricks.</p>
<p>The pet refuses to enter activities or do tricks.</p>	<p>Some of the pet indices may have dropped too low, please check the pet status in CLIPBOARD &gt; Pet Status and do related actions.</p>
<p>You are not able to record pet responses.</p>	<ol style="list-style-type: none"> <li>1. Start speaking after the countdown.</li> <li>2. Speak clearly into the microphone.</li> </ol>









<p>The number of coins i have has reduced.</p>	<p>Some of the activities in PET CENTRE and OUTINGS will cost coins. Please refer to those sections of the manual for details.</p>
<p>The pet's level has never increased.</p>	<ol style="list-style-type: none"> <li>1. Ensure you have completed all necessary tasks everyday. Please refer to the START PLAYING &gt; Everyday Tasks section for details.</li> <li>2. When you have got a mission, please go to the correct activity to complete the mission, your pet will not move onto the next level until the mission is completed.</li> </ol>
<p>Cannot earn more money.</p>	<p>Once your pet becomes a millionaire you will not be able to collect anymore coins as you will have reached the coin limit.</p>

# APPENDIX

**NOTE:** The tricks or items marked with  means they are secret tricks or items and are locked at the beginning. You can unlock these as your pet reaches new levels of game play.

**Table 1 – All Items & Food**

	Item	
1	 Cone	
2	 Kite	
3	 Ball	
4	 Skateboard	
5	 Piano	Available in MARKET after Mission 1.
6	 Guitar	Available in MARKET after Mission 1.
7	 Drum	Available in MARKET after Mission 1.
8	 Magnify	
9	 Trampoline	

	Item	
10	 Globe	
11	 Notebook	
12	 First Aid Box	Can use once for a quick recovery when your pet is sick.
13	 Hot Spring Ticket	Can use once.
14	 Rain head Shower	For use in CARE>Bathing.
15	 Bathtub	For use in CARE>Bathtub Bathing.
16	 Diamond	This special item is worth a lot of coins!
17	 Birthday Cake	Available in MARKET on Pet's Birthday.





































Ready to Eat Food				Home Made Food	
1	 Carrot	5	 Biscuit	1	 Carrot-shaped Sponge Cake
2	 Water	6	 Bananas	2	 Fruit Salad
3	 Pet Food	7	 Juice	3	 Apple Pie
4	 Apple			4	 Banana Pancake

Table 2 – All Tricks

Pet State	Touch Command	Trick Response	
 When the pet is up close			Different cute responses
			Moves away
			Feels loved
	Pat the IR sensor gently		Feels loved
	Speak into the microphone		Responds to what you've said



 When the pet is in Babble Talk mode			Comes closer
			Moves away
	Speak into the microphone		Repeats Voice
 When the pet is standing			Sit down
 When the pet is sitting			Get up
			Lay down
 When the pet is lying down.			Get up



When the pet is standing, sitting or laid down



Jump



Come closer



Come much closer

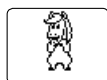

Beg



Jump right



Jump left

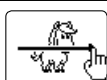

Turn around





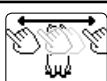



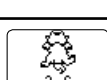

Roll over



Hands up & walk

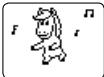

Back flip

			 Handstand
			 Break dance
			Feel loved

# CARE & MAINTENANCE

1. Keep the unit clean by wiping it with a slightly damp cloth.
2. Keep the unit out of direct sunlight and away from any direct heat source.
3. Remove the batteries or adaptor when the unit is not in use for an extended period of time.
4. Do not drop the unit on a hard surface and do not expose it to moisture or immerse it in water.

If the problem persists, please call our Consumer Services Department on 01235 546810 (from UK) or +44 1235 546810 (outside UK), and a service representative will be happy to help you.

## **IMPORTANT NOTE:**

Creating and developing **VTech®** products is accompanied by a responsibility that we take very seriously. We make every effort to ensure the accuracy of the information, which forms the value of our products. However, errors sometimes can occur. It is important for you to know that we stand behind our products and encourage you to call our Consumer Services Department on 01235 546810 (from UK) or +44 1235 546810 (outside UK) with any problems and/or suggestions that you might have. A service representative will be happy to help you.

**CLASS 1  
LED PRODUCT**

# WRIST STRAP ATTACHMENT INSTRUCTIONS

- Make sure the unit is OFF or in clock mode.
- Locate the battery cover at the back of the unit. Turn the lock clockwise for a quarter turn with a flat head screwdriver (not included).
- Remove the battery cover.
- Put the end of the wrist strap onto the thread hook as illustrated.
- Close the battery cover.

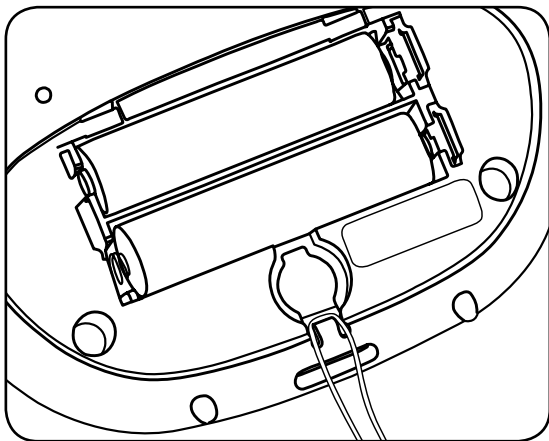



## PRODUCT WARRANTY



Thank you for choosing this quality product from VTech. We hope it will bring many hours of entertainment, imaginative play and learning.

1. The product detailed above is covered by a one year warranty from the date of purchase, against any defects in materials or workmanship.
2. The product may be returned to the place of purchase. Alternatively the product can be returned to VTech Electronics Europe plc (see address below), with proof of purchase, without proof of purchase no replacement will be provided.
3. VTech Electronics Europe plc will examine the product and if it is found to be defective due to faulty materials or workmanship, will replace the product at their discretion.
4. If the product covered by this warranty is damaged due to misuse, modification or unauthorised repair, or because of faulty batteries, battery discharge or incorrect electrical connections, then this warranty becomes void.
5. This warranty is personal to the original purchaser and is not transferable.
6. Breakages to the LCD screen are not covered by the warranty.
7. Returns to VTech Electronics Europe plc should include a cheque or postal order for £1.50 towards the cost of return postage and packaging.
8. Products returned to VTech Electronics Europe plc, should be addressed as follows and packed carefully to avoid damage in transit (Please do not include batteries or adaptor).  
Please include details of the fault together with your name and address.

VTech Electronics Europe plc, c/o Tablogix Limited, 200 Milton Park, Abingdon, Oxon OX14 4TA

**THIS WARRANTY IS OFFERED AS AN EXTRA BENEFIT AND DOES NOT AFFECT CONSUMERS' STATUTORY RIGHTS.**

Join the VTech club online at [www.vtechuk.com](http://www.vtechuk.com)



This warranty is valid for the UK and Eire only. For products purchased outside the UK and Eire, please contact your local distributor or place of purchase.